

**IABU Headquarters**

Delta Electronics, Inc.  
Taoyuan  
31-1, Xingbang Road, Guishan Industrial Zone,  
Taoyuan County 33370, Taiwan, R.O.C.  
TEL: 886-3-362-6301 / FAX: 886-3-362-7267

**Asia**

Delta Electronics (Jiang Su) Ltd.  
Wujiang Plant3  
1688 Jiangxing East Road,  
Wujiang Economy Development Zone,  
Wujiang City, Jiang Su Province,  
People's Republic of China (Post code: 215200)  
TEL: 86-512-6340-3008 / FAX: 86-512-6340-7290

Delta Greentech (China) Co., Ltd.  
238 Min-Xia Road, Cao-Lu Industry Zone, Pudong, Shanghai,  
People's Republic of China  
Post code: 201209  
TEL: 021-58635678 / FAX: 021-58630003

Delta Electronics (Japan), Inc.  
Tokyo Office  
Delta Shibadaimon Building, 2-1-14  
Shibadaimon, Minato-Ku, Tokyo, 105-0012,  
Japan  
TEL: 81-3-5733-1111 / FAX: 81-3-5733-1211

Delta Electronics (Korea), Inc.  
234-9, Duck Soo Building 7F, Nonhyun-Dong,  
Kangnam-Gu, Seoul, Korea 135-010  
TEL: 82-2-515-5305 / FAX: 82-2-515-5302

Delta Electronics (Singapore) Pte. Ltd.  
8 Kaki Bukit Road 2, #04-18 Ruby Warehouse Complex,  
Singapore 417841  
TEL: 65-6747-5155 / FAX: 65-6744-9228

Delta Power Solutions (India) Pte. Ltd.  
Plot No. 28, Sector-34, EHTP  
Gurgaon-122001 Haryana, India  
TEL: 91-124-416-9040 / FAX: 91-124-403-6045

**America**

Delta Products Corporation (USA)  
Raleigh Office  
P.O. Box 12173, 5101 Davis Drive,  
Research Triangle Park, NC 27709, U.S.A.  
TEL: 1-919-767-3813 / FAX: 1-919-767-3969

Delta Products Corporation (Brazil)  
Sao Paulo Office  
Rua Itapeva, Nº 26, 3º andar, Bela vista  
ZIP: 01332-000 - São Paulo - SP - Brasil  
TEL: 55-11-3568-3875 / FAX: 55-11-3568-3865

**Europe**

Deltronics (The Netherlands) B.V.  
Eindhoven Office  
De Witbogt 15, 5652 AG Eindhoven, The Netherlands  
TEL: 31-40-2592850 / FAX: 31-40-2592851

# VFD C2000

Classical Field Oriented Control AC Motor Drive



## High Reliability, Easy to Use, A Combination of Intelligence and Versatility for Ultimate Performance

Delta Electronics, a leading brand of drive technology, has officially launched the most cost-effective VFD-C2000 series, a classical field oriented control AC motor drive. With 4 good CP values (high efficiency, high performance, low cost of maintenance and long product life), customers are able to raise the competition and save cost at the same time.

### Main Functions and Features

- Field oriented control with built-in PLC function
- Wide variety of applications
- Wide range of models to meet requirements
- Modular design for easy maintenance and many extensions
- High-speed communication interface and built-in CANopen and MODBUS (PROFIBUS-DP, DeviceNet, MODBUS TCP and EtherNet/IP cards are optional accessories)
- Long-life design and life detection of important components
- Enhanced protections and adaptation to ambient conditions
- Complies with global safety standards, including CE, UL and cUL

### Standard Models (IP20/NEMA1)

Power range: 230V 0.75~90kW, 460V 0.75~355kW

230V (kW)	0.75	1.5	2.2	3.7	5.5	7.5	11	15	18.5	22	30	37	45	55	75	90
230V (HP)	1	2	3	5	7.5	10	15	20	25	30	40	50	60	75	100	125
Frame Size	A			B			C		D		E		F*			
460V (kW)	0.75	1.5	2.2	3.7	4.0	5.5	7.5	11	15	18.5	22	30	37	45	55	75
460V (HP)	1	2	3	5	5	7.5	10	15	20	25	30	40	50	60	75	100
Frame Size	A				B				C				D			
460V (kW)	90	110	132	160	185	220	280	315	355							
460V (HP)	125	150	175	215	250	300	375	425	475							
Frame Size	E		F*		G*		H*									

\*NOTE: Available in 2010 Q2



# C2000

## Leading the Future of Drive Technology

VFD-C series uses FOC control as the core technology to fulfil the demands of high starting torque, accurate speed and torque control. Suitable for many applications it offers PID adjustment, simple operation interface, flexible I/O extension, fieldbus modules, wide power range, complete protection, adaptation to harsh ambient conditions, long-life design, compliance with global safety standards (CE/UL/cUL), competitive market price, easy maintenance, low malfunction rate and self diagnosis.

### High-performance Variable-frequency Technology

1. Control bandwidth up to 600Hz
2. Speed/torque/position control mode
3. Dual rating design (Normal duty/heavy duty)
4. Outstanding 4-quadrant torque control/limit
5. 2 in 1 (induction motor and synchronous motor)\*

\*NOTE: Available in 2010 Q1

### Versatile Driving Controls

1. Built-in safe stop function
2. Built-in PLC
3. Built-in brake unit
4. Support various network protocols
5. Synchronous position control



### Modular Design

1. Hot-plugging digital keypad
2. I/O extension cards
3. Various PG (encoder) feedback cards
4. Network cards for fieldbus modules
5. Removable fan

### Environmental Adaptability

1. 50°C operation temperature
2. Built-in DC reactor
3. Coated circuit boards
4. RFI filter
5. Global safety standards (CE/UL/cUL)

■ **Enhanced Motor Efficiency in General Applications**

- Improved sensorless vector control (SVC) response and torque control in, for example, crane applications.



■ **Safe Stop Function**

- VFD-C2000 series complies with safe stop standards, including EN954-1, EN60204-1 and IEC61508, to prevent personal injury from accidental start-up.

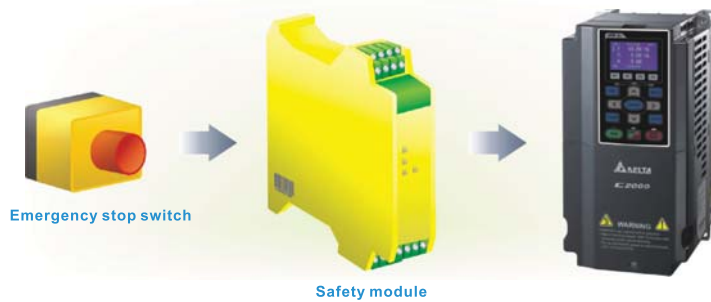

■ **High-performance Field Oriented Control**

- The best choice for high precision control of position and speed, such as the control of printing machines.

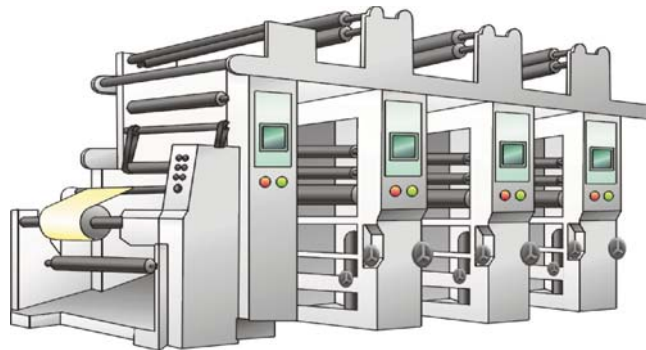

■ **High-performance Field Oriented Control**

- In FOC+PG control mode it can produce 200% start-up torque at extremely low speeds, resulting in more stable speed control.

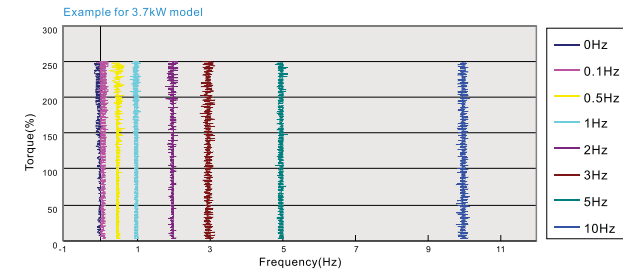

■ **Improved Load Impact**

- At load changes, VFD-C2000 will provide the best torque response by FOC to reduce motor speed changes to a minimum to prevent vibration.

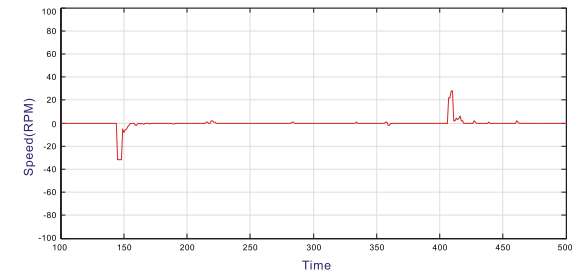

■ **Innovative PID Technology**

- Apart from traditional PI control, VFD-C2000 also provides PDFF control in speed regulation to eliminate overshoot and increase response time.

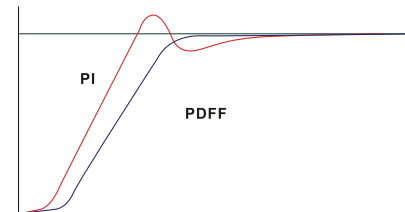

**Intelligent Programmable Logical Controller**

- In network systems, distributed control and independent operation can easily be achieved with the built-in Delta PLC.

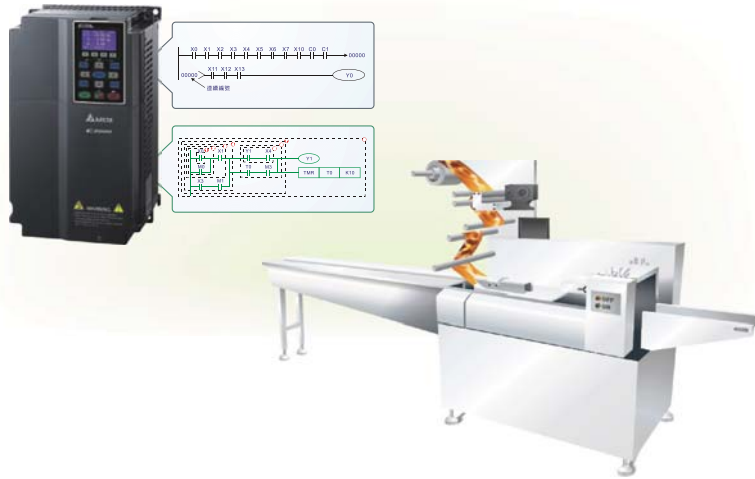

**Able to Drive Permanent Magnet (PM) Motor**

- VFD-C2000 series offers 2-in-1 function for induction motors and permanent magnet motors to precisely control position, speed and torque by dynamic response of permanent magnet motors. (available in 2010 Q1)

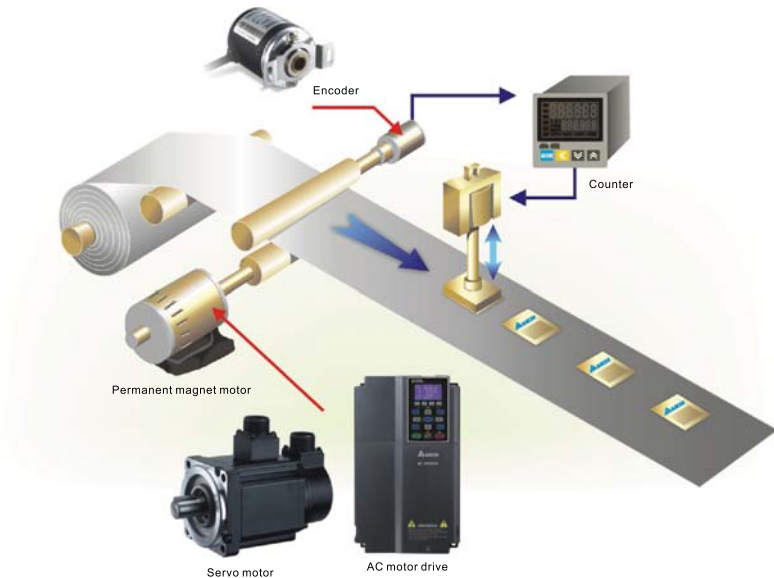

**Modular Design**

- The modular design fulfils the needs of system applications and equipment maintenance.



- Provides various accessories, including I/O extension cards, encoder feedback cards, communication cards, hot-plugging LCM keypad, removable terminals and removable fan.

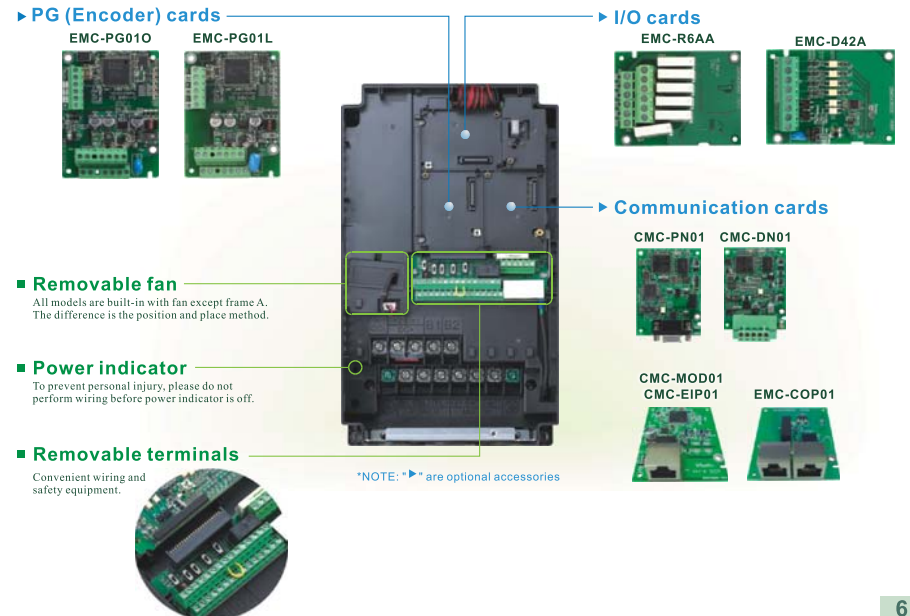

## High-speed Network Building

- Provides various communication network cards and fieldbus cards
- Built-in RS-485 international standard communication interface
- Advanced network functions



### CANopen (DS402), built-in

Delta develops the software CANopen Builder exclusively designed for CANopen communication. It provides users with a more convenient interface for motion control and greatly increases productivity.

- Supports all Delta industrial automation products (all EDS files of Delta industrial automation products are built-in)
- I/O data layout of each equipment on the CANopen network
- Planning function for motion control
- WPL Soft
- TAP-CN03 distribution box for long distances

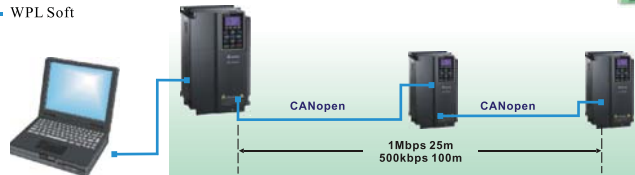

### DeviceNet

Delta DeviceNet Builder software is particularly designed for DeviceNet communication. With this software, it is easy to plan DeviceNet equipment and remote I/O via parameters to build a standard DeviceNet monitoring structure.

- DeviceNet layout software
- Supports all Delta industrial automation products (all EDS files of Delta industrial automation products are built-in)
- I/O data layout of each equipment in DeviceNet network



### MODBUS TCP

Delta's communication integrator software not only provides graphic module setting and human interface design but also supports settings and online monitoring for all Ethernet products

- Delta software for Ethernet/MODBUS TCP products
- Auto search function
- Graphic module setting and human interface design
- Setting interface for virtual COM port



\*NOTE: please download the software above at Delta website

## Environmental Adaptability Design

- Those models which have built-in with DC reactor and RFI filter comply with IEC/EN61000-3-2, 61000-3-12 and 61800-3 standards.
- Reduces harmonics and noise interference effectively
- Strong coating to ensure safe operation in harsh environments
- Heatsink and electronics components are completely isolated from each other. With the following two heatsink designs, the best cooling according to requirements is achieved:
  - (1) Flange mounting: Heat from the drive can be dissipated out of the cabinet
  - (2) Forced fan cooling: Blow cool air into aluminum heatsink.



## Convenient Operation Platform for Drive System Management

- Provides a complete operation platform for users' easy control and monitoring via PC, including parameters save/setting, real-time wave monitor, quick setup, support multiple languages and compatible multi-language operation systems.

**Quick setup** ←  
Guides the user step-by-step through the complete drive's setting according to quick setup wizard.

**Trend records** ←  
It monitors operation curves of the drive by communication and displays I/O terminal status. Useful for e.g. Trial run monitoring.

→ **Parameter management**  
Provides parameter setting/save/copy/comparison for convenient parameter management.

→ **Start-up display**  
Display horsepower, rated voltage and current of present model

## Ordering information

<b>Frame A</b> 	<b>230V:</b> 0.75~3.7kW (1~5HP)  <b>460V:</b> 0.75~5.5kW (1~7.5HP)	VFD007C23A/E VFD037C23A/E VFD007C43A/E VFD015C43A/E VFD037C43A/E VFD040C43A/E VFD055C43A/E  VFD015C23A/E VFD022C23A/E VFD022C43A/E	▶ Flange mounting kit 「MKC-AFM」  ▶ Flange mounting kit 「MKC-AFM1」
<b>Frame B</b> 	<b>230V:</b> 5.5~11kW (7.5~15HP)  <b>460V:</b> 7.5~15 kW (10~20HP)	VFD055C23A/E VFD075C23A/E VFD110C23A/E VFD075C43A/E VFD110C43A/E VFD150C43A/E	▶ Flange mounting kit 「MKC-BFM」
<b>Frame C</b> 	<b>230V:</b> 15~22 kW (20~30HP)  <b>460V:</b> 18.5~30 kW (25~40HP)	VFD150C23A/E VFD185C23A/E VFD220C23A/E VFD185C43A/E VFD220C43A/E VFD300C43A/E	▶ Flange mounting kit 「MKC-CFM」
<b>Frame D</b> 	<b>230V:</b> 30~37 kW (40~50HP)  <b>460V:</b> 37~75 kW (50~100HP)	VFD300C23A VFD370C23A VFD370C43A VFD450C43A VFD550C43A VFD750C43A VFD300C23E VFD370C23E VFD370C43E VFD450C43E VFD550C43E VFD750C43E	▶ Conduit box kit 「MKC-DN1CB」
<b>Frame E</b> 	<b>230V:</b> 45~75 kW (60~100HP)  <b>460V:</b> 90~110 kW (125~150HP)	VFD450C23A/E VFD550C23A/E VFD750C23A VFD900C43A/E VFD1100C43A/E VFD750C23E	▶ Conduit box kit 「MKC-EN1CB」
<b>Frame F</b> 	<b>230V:</b> 90 kW (125HP)  <b>460V:</b> 132~160 kW (175~215HP)	VFD900C23A/E VFD1320C43A/E VFD1600C43A/E	available in 2010 Q2
<b>Frame G</b> 	<b>460V:</b> 185~220 kW (250~300HP)	VFD1850C43A/E VFD2200C43A/E	available in 2010 Q2
<b>Frame H</b> 	<b>460V:</b> 280~355 kW (375~475HP)	VFD2800C43A/E VFD3150C43A/E VFD3550C43A/E	available in 2010 Q2

\*NOTE: "▶" are optional accessories

## Nameplate

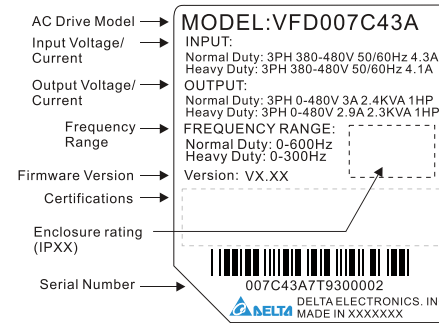

**MODEL:VFD007C43A**

AC Drive Model →

Input Voltage/Current → INPUT:  
Normal Duty: 3PH 380-480V 50/60Hz 4.3A  
Heavy Duty: 3PH 380-480V 50/60Hz 4.1A

Output Voltage/Current → OUTPUT:  
Normal Duty: 3PH 0-480V 3A 2.4KVA 1HP  
Heavy Duty: 3PH 0-480V 2.9A 2.3KVA 1HP

Frequency Range → FREQUENCY RANGE:  
Normal Duty: 0-600Hz  
Heavy Duty: 0-300Hz

Firmware Version → Version: VX.XX

Certifications →

Enclosure rating (IPXX) →

Serial Number → 007C43A7T9300002

DELTA ELECTRONICS, INC.  
MADE IN XXXXXXXX

## Model name

**VFD 007 C 43 A**

VFD: Series name (Variable Frequency Drive)









007: Applicable motor power in kW (007:1HP(0.75kW)~1100:150HP(110kW). Refer to the specifications for details)

C: C2000 series

43: Input voltage (23:230V 3-Phase, 43:460V 3-Phase)

A: Version type

## Optional Accessories

Communication card	<b>CMC-EIP01</b> <b>CMC-MOD01</b> 	<b>EtherNet/IP (CMC-EIP01)</b> <b>MODBUS TCP (CMC-MOD01)</b> 10/100 Mbps Auto-Detect
	<b>CMC-PN01</b> 	<b>PROFIBUS-DP</b> Supports 9.6kbps, 19.2kbps, 96.75kbps, 187.5kbps, 500kbps, 1.5Mbps, 3Mbps, 6Mbps and 12Mbps
	<b>CMC-DN01</b> 	<b>DeviceNet</b> 125kbps, 250kbps, 500kbps and extenable serial transmission speed
I/O card	<b>EMC-COP01</b> 	<b>CANopen</b> 1M 500k 250k 125k 100k 50k
	<b>EMC-R6AA</b> 	Relay card (6 relays)
PG (encoder) card	<b>EMC-D42A</b> 	I/O extension card (4 digital inputs and 2 digital outputs)
	<b>EMC-PG010</b> 	PG output signal with frequency division function: Open collector output signal. It requires a pull-up resistor to external power V+ (such as PLC power) to prevent noise interference. Max. output frequency: 300kPulse/Sec
Digital keypad	<b>EMC-PG01L</b> 	PG output signal with frequency division function: Max. output voltage of line driver: 5VDC Max. output current: 50mA Max. output frequency: 300kPulse/Sec
	<b>KPC-CE01</b> 	7-segment display with menu function: easy, convenient operation, multi-function keys, warning indicators and fault code display  <b>Panel mounting (MKC-KPPK)</b> IP56 protection level, can be mounted flat on the surface of a cabinet and the front cover is waterproof. Two ways of panel mounting: wall mounting and embedded mounting. Customers are able to install as required.

Wiring

Frame A~C

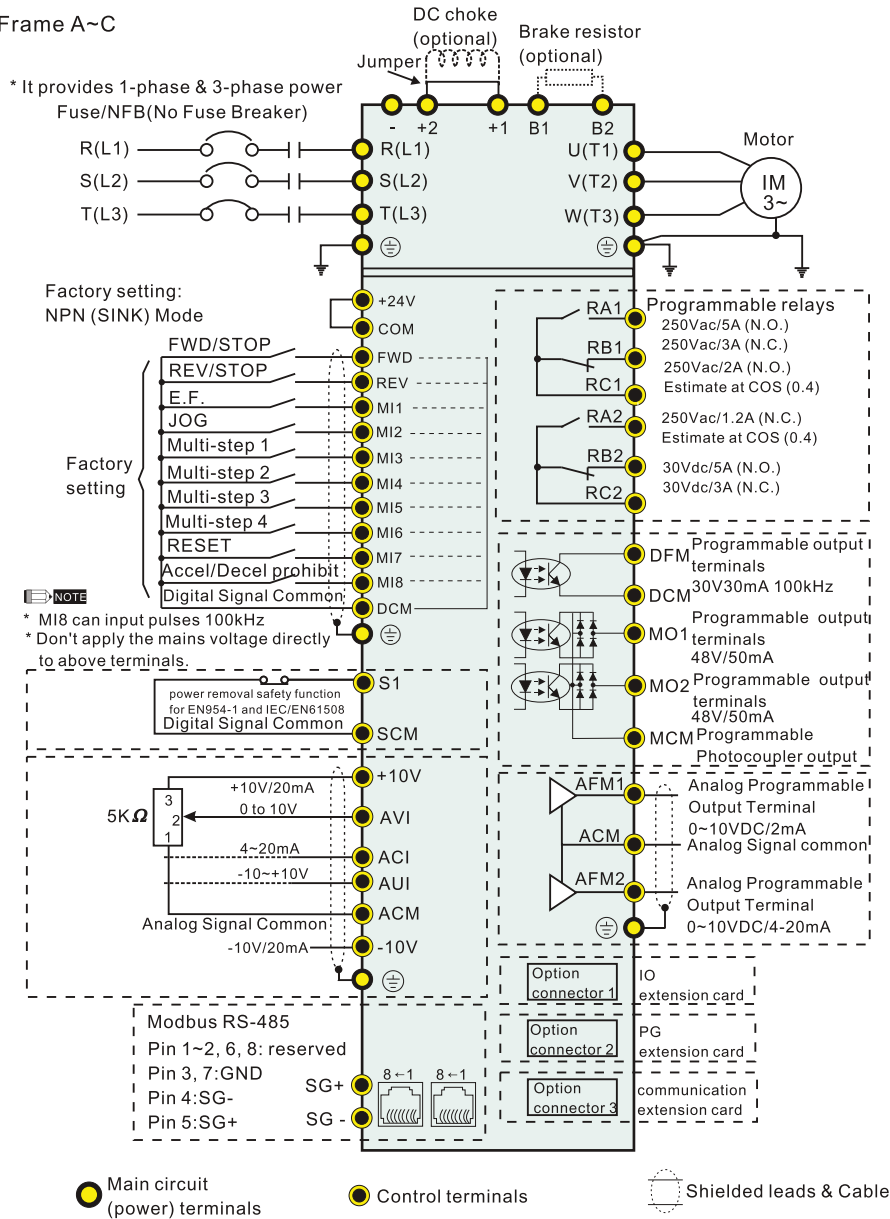

Frame D and above

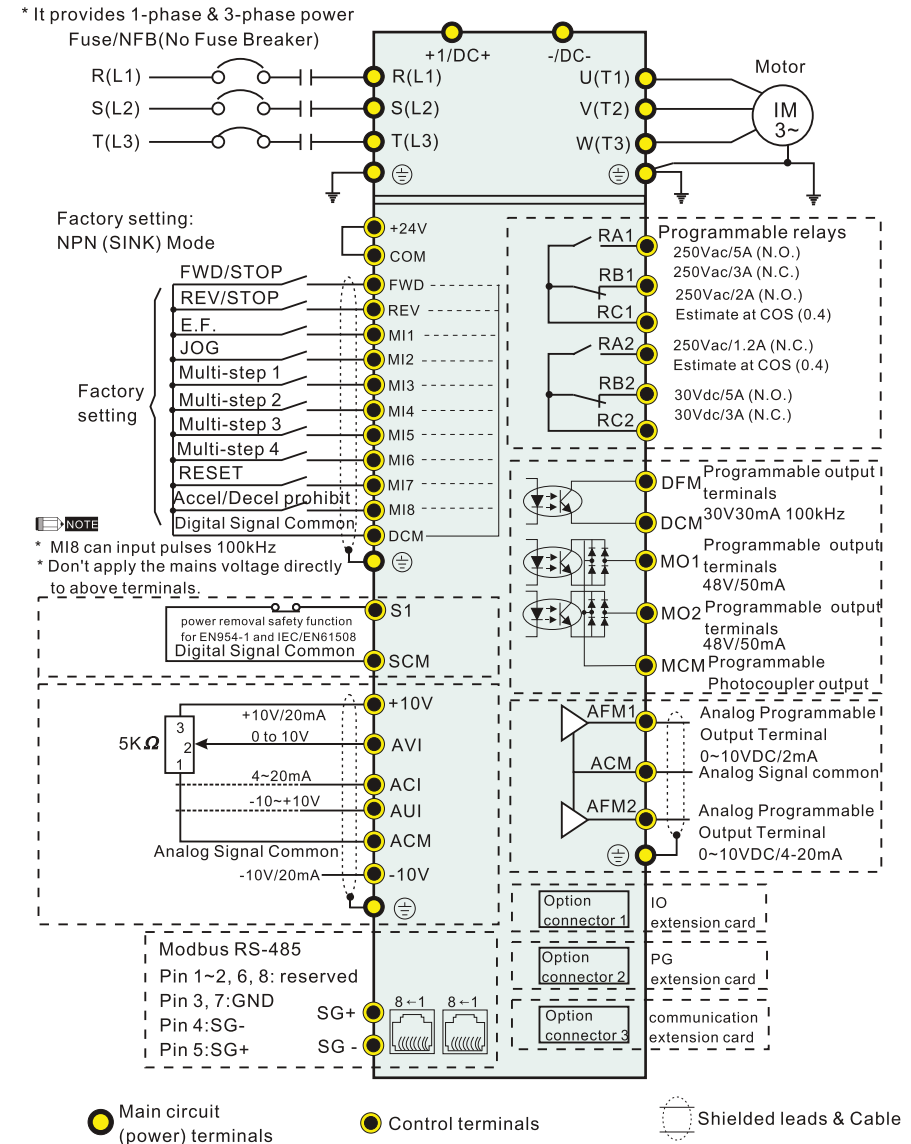

## Specifications

230V		A					B					C					D					E									
Frame Size																															
Model Number VFD-__C__		007	015	022	037	055	075	110	150	185	220	300	370	450	550	750	007	015	022	037	055	075	110	150	185	220	300	370	450	550	750
Max. Applicable Motor Output (kW)		0.75	1.5	2.2	3.7	5.5	7.5	11	15	18.5	22	30	37	45	55	75	0.75	1.5	2.2	3.7	5.5	7.5	11	15	18.5	22	30	37	45	55	75
Max. Applicable Motor Output (hp)		1	2	3	5	7.5	10	15	20	25	30	40	50	60	75	100	1	2	3	5	7.5	10	15	20	25	30	40	50	60	75	100
Output Rating	HEAVY DUTY																														
	Rated Output Capacity (kVA)	1.9	2.8	4.0	6.4	9.6	12	19	25	28	34	45	55	68	81	96	1.9	2.8	4.0	6.4	9.6	12	19	25	28	34	45	55	68	81	96
	Rated Output Current (A)	4.8	7.1	10	16	24	31	47	62	71	86	114	139	171	204	242	4.8	7.1	10	16	24	31	47	62	71	86	114	139	171	204	242
Output Rating	NORMAL DUTY																														
	Rated Output Capacity (kVA)	2.0	3.2	4.4	6.8	10	13	20	26	30	36	48	58	72	86	102	2.0	3.2	4.4	6.8	10	13	20	26	30	36	48	58	72	86	102
	Rated Output Current (A)	5	8	11	17	25	33	49	65	75	90	120	146	180	215	255	5	8	11	17	25	33	49	65	75	90	120	146	180	215	255
Input Rating	Carrier Frequency (kHz)	2~6kHz																													
	Carrier Frequency (kHz)	2~10kHz																													
	Carrier Frequency (kHz)	2~9kHz																													
	Input Current (A) Heavy Duty	6.1	11	15	18.5	26	34	50	68	78	95	118	136	162	196	233	6.1	11	15	18.5	26	34	50	68	78	95	118	136	162	196	233
	Input Current (A) Normal Duty	6.4	12	16	20	28	36	52	72	83	99	124	143	171	206	245	6.4	12	16	20	28	36	52	72	83	99	124	143	171	206	245
	Rated Voltage/Frequency	3-phase AC 200V -15%~240V +10%, 50/60Hz																													
	Operating Voltage Range	170~265Vac																													
	Frequency Tolerance	47~63Hz																													
	Cooling Method	Natural										Fan cooling																			
	Braking Chopper											Built-in					Option														
DC Reactor											Option					Built-in															
EMI Filter	Option																														

## General Specifications

Control Characteristics	Control Method	1: V/F, 2: SVC, 3: VF+PG, 4: FOC+PG
	Starting Torque	up to 150% or above at 0.5Hz; up to 150% at 0Hz for 1 minute
	V/f Curve	4-point adjustable V/f curve & square curve
	Speed Response Bandwidth	5Hz (vector control can be up to 40Hz)
	Torque Limit	Max. 200% torque current
	Torque Accuracy	±5%
	Max. Output Frequency (Hz)	Normal duty: 0.01~600.00Hz; Heavy duty: 0.00~300.00 Hz
	Frequency Output Accuracy	Digital command: ±0.01%, -10°C ~ +40°C, Analog command: ±0.1%, 25 ±10°C
	Frequency Setting Resolution	Digital command: 0.01Hz, Analog command: 0.03/60 Hz (±11 bits)
	Overload Tolerance	Normal duty: 120% of rated output current for 1 min. Heavy duty: 150% of rated output current for 1 min.
Frequency Setting Signal	+10V~-10.0V~+10V, 4~20mA, 0~20mA, Pulse input	
Accel./decel. Time	0.00~600.00/0.0~6000.0 Seconds	
Protection Characteristics	Main Control Function	Torque control, Droop control, Speed/torque control switching, Feed forward control, Zero-servo control, Momentary power loss ridethru, Speed search, Over-torque detection, Torque limit, 16-step speed (including master speed), Accel/decel time switch, S-curve accel/decel, 3-wire sequence, Auto-Tuning (rotational, stationary), Dwell, Slip compensation, Torque compensation, Skip frequency, Frequency upper/lower limit settings, DC injection braking at start/stop, High slip braking, PID control (with sleep function), Energy saving control, MODBUS communication (RS-485 RJ45) max. 115.2 kbps), Fault restart and Parameter copy
	Fan Control	Frame B and below: ON/OFF switch; frame C and above: PWM control
	Motor Protection	Electronic thermal relay protection
	Over-current Protection	The current forces 240% of the over-current protection Current clamp: normal duty: 170~175%; heavy duty: 180~185%
	Over-voltage Protection	230: drive will stop when DC-BUS voltage exceeds 410V 460: drive will stop when DC-BUS voltage exceeds 820V
	Over-temperature Protection	Built-in temperature sensor
	Stall Prevention	Stall prevention during acceleration, deceleration and running independently.
	Re-start after Momentary Power Off	Parameter setting can be up to 20 seconds
	Ground Current Protection	Ground current protection level is 50% of rated current of the AC motor drive

460V		A					B					C					D					E															
Frame Size																																					
Model Number VFD-__C__		007	015	022	037	040	055	075	110	150	185	220	300	370	450	550	750	900	1100	007	015	022	037	040	055	075	110	150	185	220	300	370	450	550	750	900	1100
Max. Applicable Motor Output (kW)		0.75	1.5	2.2	3.7	4.0	5.5	7.5	11	15	18.5	22	30	37	45	55	75	90	110	0.75	1.5	2.2	3.7	4.0	5.5	7.5	11	15	18.5	22	30	37	45	55	75	90	110
Max. Applicable Motor Output (hp)		1	2	3	5	5	7.5	10	15	20	25	30	40	50	60	75	100	125	150	1	2	3	5	5	7.5	10	15	20	25	30	40	50	60	75	100	125	150
Output Rating	HEAVY DUTY																																				
	Rated Output Capacity (kVA)	2.3	3.0	4.5	6.5	7.6	9.6	14	18	24	29	34	45	55	69	84	114	136	167	2.3	3.0	4.5	6.5	7.6	9.6	14	18	24	29	34	45	55	69	84	114	136	167
	Rated Output Current (A)	2.9	3.8	5.7	8.1	9.5	11	17	23	30	36	43	57	69	86	105	143	171	209	2.9	3.8	5.7	8.1	9.5	11	17	23	30	36	43	57	69	86	105	143	171	209
Output Rating	NORMAL DUTY																																				
	Rated Output Capacity (kVA)	2.4	3.2	4.8	7.2	8.4	10	14	19	25	30	36	48	58	73	88	120	143	175	2.4	3.2	4.8	7.2	8.4	10	14	19	25	30	36	48	58	73	88	120	143	175
	Rated Output Current (A)	3.0	4.0	6.0	9.0	10.5	12	18	24	32	38	45	60	73	91	110	150	180	220	3.0	4.0	6.0	9.0	10.5	12	18	24	32	38	45	60	73	91	110	150	180	220
Input Rating	Carrier Frequency (kHz)	2~10kHz																																			
	Carrier Frequency (kHz)	2~15kHz																																			
	Carrier Frequency (kHz)	2~9kHz																																			
	Input Current (A) Heavy Duty	4.1	5.6	8.3	13	14.5	16	19	25	33	38	45	60	70	96	108	149	159	197	4.1	5.6	8.3	13	14.5	16	19	25	33	38	45	60	70	96	108	149	159	197
	Input Current (A) Normal Duty	4.3	5.9	8.7	14	15.5	17	20	26	35	40	47	63	74	101	114	157	167	207	4.3	5.9	8.7	14	15.5	17	20	26	35	40	47	63	74	101	114	157	167	207
	Rated Voltage/Frequency	3-phase AC 380V -15%~480V +10%, 50/60Hz																																			
	Operating Voltage Range	323~528Vac																																			
	Frequency Tolerance	47~63Hz																																			
	Cooling Method	Natural										Fan cooling																									
	Braking Chopper											Built-in					Option																				
DC Reactor											Option					Built-in																					
EMI Filter											VFDXXXC43A: without EMI filter VFDXXXC43E: built-in EMI filter					VFDXXXC43A: have to be used with conduit box kit; VFDXXX43E: NEMA1																					

## Environment for Operation, Storage and Transportation

DO NOT expose the AC motor drive to bad ambient conditions, such as dust, direct sunlight, corrosive/inflammable gasses, humidity, liquids and vibration. The salt deposit from the air must be less than 0.01mg/cm<sup>2</sup> each year.

Environment	Installation location	IEC60364-1/IEC60664-1 Pollution degree 2, Indoor use only	
	Surrounding Temperature	Operation	NEMA 1/UL Type 1 When operating at rated current, the surrounding temperature must be within -10~+40°C. For 40°C~60°C, please derate 2% rated current per increasing 1°C.
		UL Open Type	When operating at rated current, the surrounding temperature must be within -10~+50°C. For 50°C~60°C, please derate 2% rated current per increasing 1°C.
	Storage/Transportation	-25°C ~ +70°C	
		No condensation, no frost	
	Rated Humidity	Operation	Max. 90%
		Storage/Transportation	Max. 95%
	Air Pressure	Operation/Storage	86 to 106 kPa
		Transportation	70 to 106 kPa
	Pollution Level	IEC60721-3-3 (application is in progress)	
Operation		Class 3C2 : Class 3S2	
Storage		Class 2C2 : Class 2S2	
Transportation		Class 1C2 : Class 1S2	
No condensation			
Altitude	Operation	0-1000m For 1000-3000m, please derate 2% rated current or decrease 0.5°C surrounding temperature per 100m. The corner grounded system can only be used at 2000m and below.	
Package Drop	Storage/Transportation	ISTA procedure 1A(according to weight) IEC60068-2-31	
Vibration	1.5mm peak to peak, 3-13Hz, 1G from 13-200 Hz (comply with IEC 60068-2-6)		
Shock Resistance	15G for 11 ms (comply with IEC/EN 60068 2-27)		
Operation Position	Max. allowed offset angle ±10° (for normal installation position)		



■ Dimensions

■ Frame A

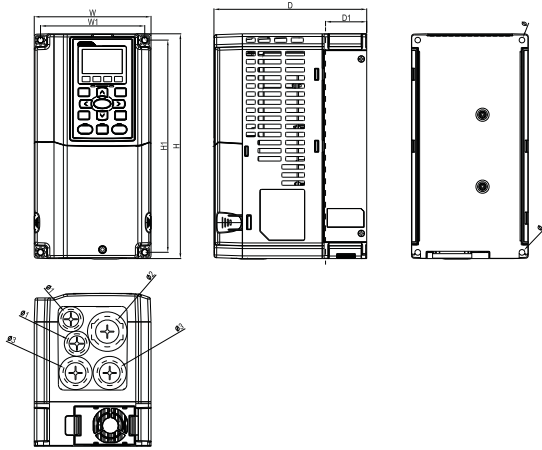

**MODEL**

- VFD007C23A/23E
- VFD007C43A/43E
- VFD015C23A/23E
- VFD015C43A/43E
- VFD022C23A/23E
- VFD022C43A/43E
- VFD037C23A/23E
- VFD037C43A/43E
- VFD040C43A/43E
- VFD055C43A/43E

Frame		W	H	D	W1	H1	D1*	Ø	Ø1	Ø2	Ø3
A	mm	130.0	250.0	170.0	116.0	236.0	45.8	6.2	22.2	34.0	28.0
	inch	5.12	9.84	6.69	4.57	9.29	1.80	0.24	0.87	1.34	1.10

■ Frame C

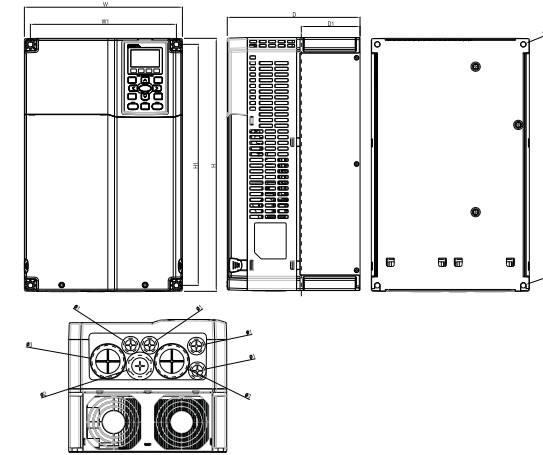

**MODEL**

- VFD150C23A/23E
- VFD185C23A/23E
- VFD185C43A/43E
- VFD220C23A/23E
- VFD220C43A/43E
- VFD300C43A/43E

Frame		W	H	D	W1	H1	D1*	Ø	Ø1	Ø2	Ø3
C	mm	250.0	400.0	210.0	231.0	381.0	92.9	8.5	22.2	34.0	50.0
	inch	9.84	15.75	8.27	9.09	15.00	3.66	0.33	0.87	1.34	1.97

■ Frame B

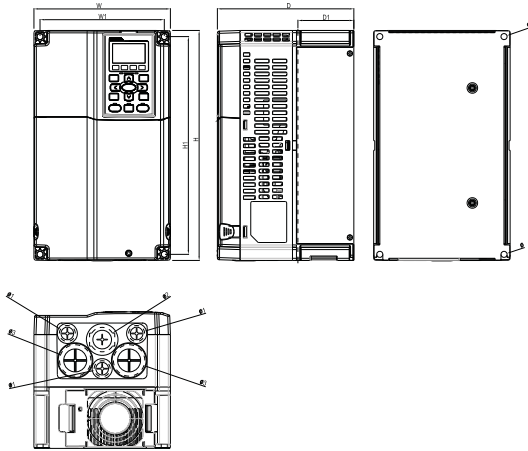

**MODEL**

- VFD055C23A/23E
- VFD075C23A/23E
- VFD075C43A/43E
- VFD110C23A/23E
- VFD110C43A/43E
- VFD150C43A/43E

Frame		W	H	D	W1	H1	D1*	Ø	Ø1	Ø2	Ø3
B	mm	190.0	320.0	190.0	173.0	303.0	77.9	8.5	22.2	34.0	43.8
	inch	7.48	12.60	7.48	6.81	11.93	3.07	0.33	0.87	1.34	1.72

■ Frame D

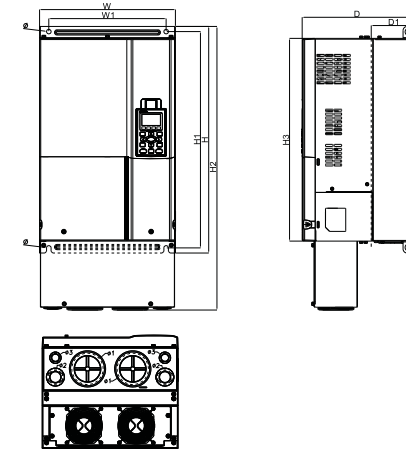

**MODEL**

- |                |                 |
|----------------|-----------------|
| <b>FRAME D</b> | <b>FRAME D1</b> |
| VFD300C23A     | VFD300C23E      |
| VFD370C23A     | VFD370C23E      |
| VFD370C43A     | VFD370C43E      |
| VFD450C43A     | VFD450C43E      |
| VFD550C43A     | VFD550C43E      |
| VFD750C43A     | VFD750C43E      |

Frame	W	H	D	W1	H1	H2	H3	D1*	Ø	Ø1	Ø2	Ø3
D	330.0	550.0	275.0	285.0	525.0	-	492.0	107.2	11.0	34.0	22.0	11.0
	[12.99]	[21.65]	[10.83]	[11.22]	[20.67]		[19.37]	[4.22]	[0.43]	[1.34]	[0.87]	[0.43]
D1	330.0	550.0	275.0	285.0	525.0	688.3	492.0	107.2	11.0	34.0	22.0	11.0
	[12.99]	[21.65]	[10.83]	[11.22]	[20.67]	[27.10]	[19.37]	[4.22]	[0.43]	[1.34]	[0.87]	[0.43]

Unit : mm[inch]

■ Dimensions

■ Frame E

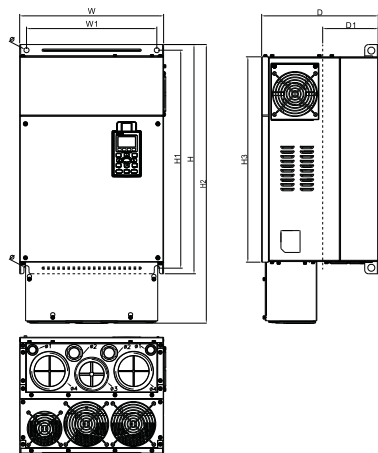

MODEL

FRAME\_E  
VFD450C23A  
VFD550C23A  
VFD900C43A  
VFD1100C43A

FRAME\_E1  
VFD450C23E  
VFD550C23E  
VFD900C43E  
VFD1100C43E

Unit : mm[inch]

Frame	W	H	D	W1	H1	H2	H3	D1*	Ø	Ø1	Ø2	Ø3	Ø4
E	370.0 [14.57]	589.0 [23.19]	300.0 [11.81]	335.0 [13.19]	560.0 [22.05]	-	528.0 [20.80]	143.0 [5.63]	13.0 [0.51]	22.0 [0.87]	34.0 [1.34]	76.0 [2.99]	92.0 [3.62]
E1	370.0 [14.57]	589.0 [23.19]	300.0 [11.81]	335.0 [13.19]	560.0 [22.05]	715.8 [28.18]	528.0 [20.80]	143.0 [5.63]	13.0 [0.51]	22.0 [0.87]	34.0 [1.34]	76.0 [2.99]	92.0 [3.62]

D1\* : Flange mounting

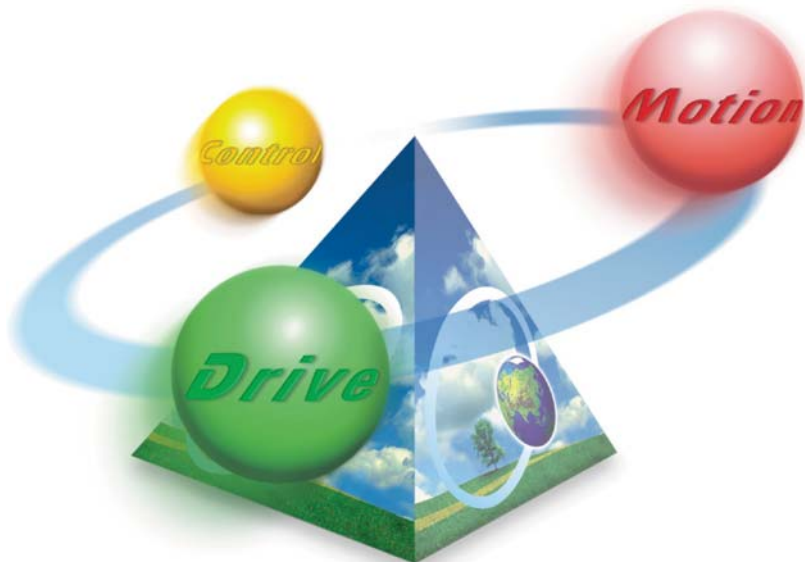

Attentions

■ Standard Motors

- **Used with 400V Standard Motors**  
It is recommended to add an AC output reactor when using with a 400V standard motor to prevent damage to motor insulation.
- **Torque Characteristics and Temperature Rise**  
When a standard motor is drive controlled, the motor temperature will be higher than with DOL operation. Please reduce the motor output torque when operating at low speeds to compensate less cooling efficiency. For continuous constant torque at low speeds, external forced motor cooling is recommended.

• **Vibration**  
When the motor drives the machine, resonances may occur, including machine resonances. Abnormal vibration may occur when operating a 2-pole motor at 60Hz or higher.

• **Noise**  
When a standard motor is drive controlled, the motor noise will be higher than with DOL operation. To lower the noise, please increase the carrier frequency of the drive. The motor fan can be very noisy when the motor speed exceeds 60Hz.

■ Special Motors

- **High-speed Motor**  
To ensure safety, please try the frequency setting with another motor before operating the high-speed motor at 120Hz or higher.
- **Explosion-proof Motor**  
Please use a motor and drive that comply with explosion-proof requirements.
- **Submersible Motor & Pump**  
The rated current is higher than that of a standard motor. Please check before operation and select the capacity of the AC motor drive carefully. The motor temperature characteristics differ from a standard motor, please set the motor thermal time constant to a lower value.
- **Brake Motor**  
When the motor is equipped with a mechanical brake, the brake should be powered by the mains supply. Damage may occur when the brake is powered by the drive output. Please DO NOT drive the motor with the brake engaged.
- **Gear Motor**  
In gearboxes or reduction gears, lubrication may be reduced if the motor continuously is operated at low speeds. Please DO NOT operate in this way.
- **Synchronous Motor**  
These kind of motors need suitable software to control them. Please contact Delta for more information.
- **Single-phase Motor**  
Single-phase motors are not suitable for being operated by an AC Motor Drive. Please use a 3-phase motor instead when necessary.

■ Environmental Conditions

- **Installation Position**  
1. The drive is suitable to be installed in a place with ambient temperature from -10 to 50°C.  
2. The surface temperature of the drive and brake resistor will rise under specific operation conditions. Therefore, please install the drive on materials that are noncombustible.  
3. Ensure that the installation place complies with the ambient conditions as stated in the manual.

■ Wiring

- **Limit of Wiring Distance**  
For the remote operation, please use twist-shielding cable and the distance between the drive and control box should be less than 20m.
- **Maximum Motor Cable Length**  
Too long motor cables may cause overheating the drive or current peaks due to stray capacitance. Please ensure that the motor cable is less than 30m. If the cable length can't be reduced, please lower the carrier frequency or use an AC reactor.

- **Choose the Right Cable**  
Please refer to current value to choose the right cable section with enough capacity or use recommended cables.

- **Grounding**  
Please ground the drive completely by using the grounding terminal.

■ How to Choose the Drive Capacity

- **Standard Motor**  
Please select the drive according to applicable motor rated current listed in the drive specification. Please select the next higher power AC drive in case higher starting torque or quick acceleration/ deceleration is needed.
- **Special Motor**  
Please select the drive according to Rated current of the drive > rated current of the motor

■ Transportation and Storage

Please transport and store the drive in the place within environment specifications.

■ Peripheral Equipment

- **Molded-Case Circuit Breakers (MCCB)**  
Please install the recommended MCCB or ELCB in the main circuit of the drive and make sure that the capacity of the breaker is equal to or lower than the recommended one.

- **Add a Magnetic Contactor(MC) in the Output Circuit**  
When a MC installed in the output circuit of the drive to switch the motor to commercial power or other purposes, please make sure that the drive and motor are completely stopped and remove the surge absorbers from the MC before switching it.

- **Add a Magnetic Contactor (MC) in the Input Circuit**  
Please only switch the MC ONCE per hour or it may damage the drive. Please use RUN/STOP signal to switch many times during motor operation.

- **Motor Protection**  
The thermal protection function of the drive can be used to protect the motor by setting the operation level and motor type (standard motor or variable motor). When using a high-speed motor or a water-cooled motor the thermal time constant should be set to a lower value.

When using a longer cable to connect the motor thermal relay to a motor, high-frequency currents may enter via the stray capacitance. It may result in malfunctioning of the relay as the real current is lower than the setting of thermal relay. Under this condition, please lower the carrier frequency or add an AC reactor to solve this.

- **DO NOT Use Capacitors to Improve the Power Factor**  
Use a DC reactor to improve the power factor of the drive. Please DO NOT install power factor correction capacitors on the main circuit of the drive to prevent motor faults due to over current.

- **Do NOT Use Surge Absorber**  
Please DO NOT install surge absorbers on the output circuit of the drive.

- **Lower the Noise**  
To ensure compliance with EMC regulations, usually a filter and shielded wiring is used to lower the noise.

- **Method Used to Reduce the Surge Current**  
Surge currents may occur in the phase-lead capacitor of the power system, causing an overvoltage when the drive is stopped or at low loads.

It is recommended to add a DC reactor to the drive.